



aerospace  
climate control  
electromechanical  
filtration  
fluid & gas handling  
**hydraulics**  
pneumatics  
process control  
sealing & shielding



# Diaphragm Accumulators

ELM from 140 to 350 bar



ENGINEERING YOUR SUCCESS.

Day to day, the agricultural, forestry, construction and public works sectors are faced with the fundamental question:

**How to enhance driver and vehicle comfort?**

Thanks to our comprehensive range of diaphragm accumulators, we offer our customers flexibility of driving at record speeds while guaranteeing enhanced machinery longevity.

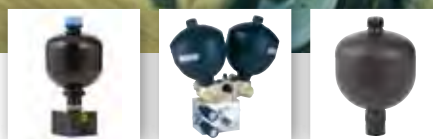

**Comparative cycle for a tractor and its accessories in working conditions !**

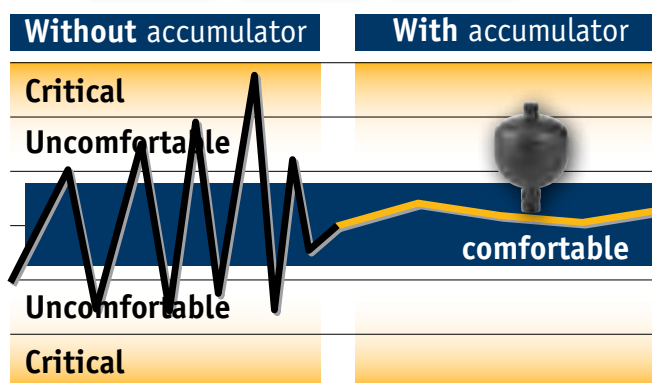

\*Study carried out in cooperation with one of the largest manufacturers of agricultural machinery



Speed 50 kph



Load variation on front axle 3,5 to 100 %

**An example\***

of application

Faced with difficult working conditions, a farm supervisor wants to **increase his driving comfort and reduce breakage** among his fleet of machines.

# Main Features

## Operation principle

Operation of the Parker Olaer gas loaded diaphragm accumulator is based on the considerable difference in compressibility between a gas and a liquid, enabling a large quantity of energy to be stored in an extremely compact form. This enables a liquid under pressure to be accumulated, stored and recovered at any time.

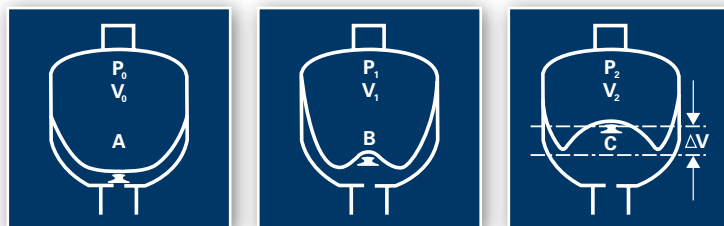

<b>V0</b> = Capacity in nitrogen of the accumulator	<b>P0</b> = Initial preload of the accumulator
<b>V1</b> = Gas volume at the minimum hydraulic pressure	<b>P1</b> = Gas pressure at the minimum hydraulic pressure
<b>V2</b> = Gas volume at the maximum hydraulic pressure	<b>P2</b> = Gas pressure at the maximum hydraulic pressure
<b><math>\Delta V</math></b> = Returned and/or stored volume of working fluid between P1 and P2	

**A** - The diaphragm is in the pre-charge position, which means that it is only filled with nitrogen. The knob closes the hydraulic orifice and prevents the destruction of the diaphragm.

**B** - Position at the minimum operating pressure : there must be a certain amount of fluid between the diaphragm and the hydraulic orifice, such that the knob does not close the hydraulic orifice. Thus, P0 must always be < P1.

**C** - Position at the maximum operating pressure: the volume change  $\Delta V$  between the minimum and maximum positions of the operating pressures represents the fluid quantity stored.

## Your Benefits

The adaptation of a hydraulic shock absorber made up of a diaphragm accumulator improves driver comfort and offers immediate response times when driving over obstacles and the same flexibility for variable operating conditions.

0 < speed < 50 kph

3.5 < load variation < 100%

Identical flexibility depending on your use.

The same EC pressure directive (PED) compliant accumulator can be used in over 35 destination countries, thus facilitating their free movement.

In addition all our ELM diaphragm accumulators have SELO approval for China.

## Technical Characteristics

The technical characteristics are as follows:

Minimum/maximum temperature allowable (° Celsius) :

- 20/+ 80 for standard nitrile elastomers for models 0.075 ≥

1.4 Litre

- 10/+ 80 for standard nitrile elastomers for models ≥ 2 Litres

- 35/+ 80 for hydrin elastomers

Materials : carbon steel or stainless steel, nitrile or hydrin diaphragm, for other constructions: consult Parker Olaer.



# How to size?

Parker Olaer has developed a very sophisticated simulation software to optimize accumulator sizing recommendations. The behaviour of accumulators used in applications such as pulsation dampening, surge alleviation, thermal expansion and energy storage can be simulated. Our software can be downloaded from our website ([www.parker.com/acde](http://www.parker.com/acde)). You may also contact your local Parker Olaer office for sizing assistance.

This sizing chart can be used, on the basis of the arrangement of the various parameters, to determine the volume of oil available, the size of the accumulator or the pressures. It does not take account of the correction for actual compressibility of the real gas, the actual adiabatic coefficient or the polytropic coefficient of the application. Depending on the conditions of use, these can have a significant effect and may entail the need for certain corrections.

**We recommend**

In load dampening configuration:  $P_0 = 0,6 - 0,9 P_m$

( $P_m$  = average working pressure)

Pulsation dampening:  $P_0 = 0,6 - 0,8 P_m$  ( $P_m$  = average working pressure)

Energy storage:  $P_0 = 0,9 P_1$  ( $P_1$  = minimum working pressure)

## Energy storage calculation sizing chart

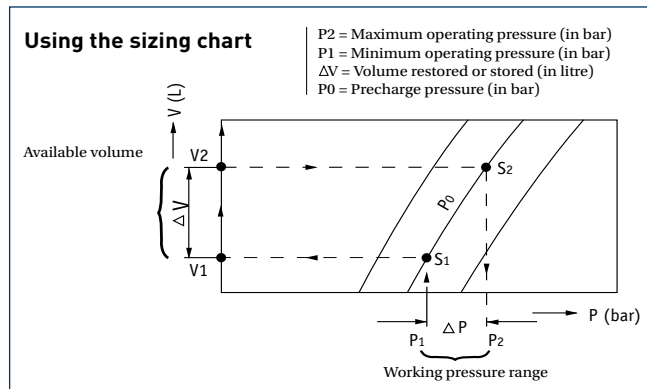
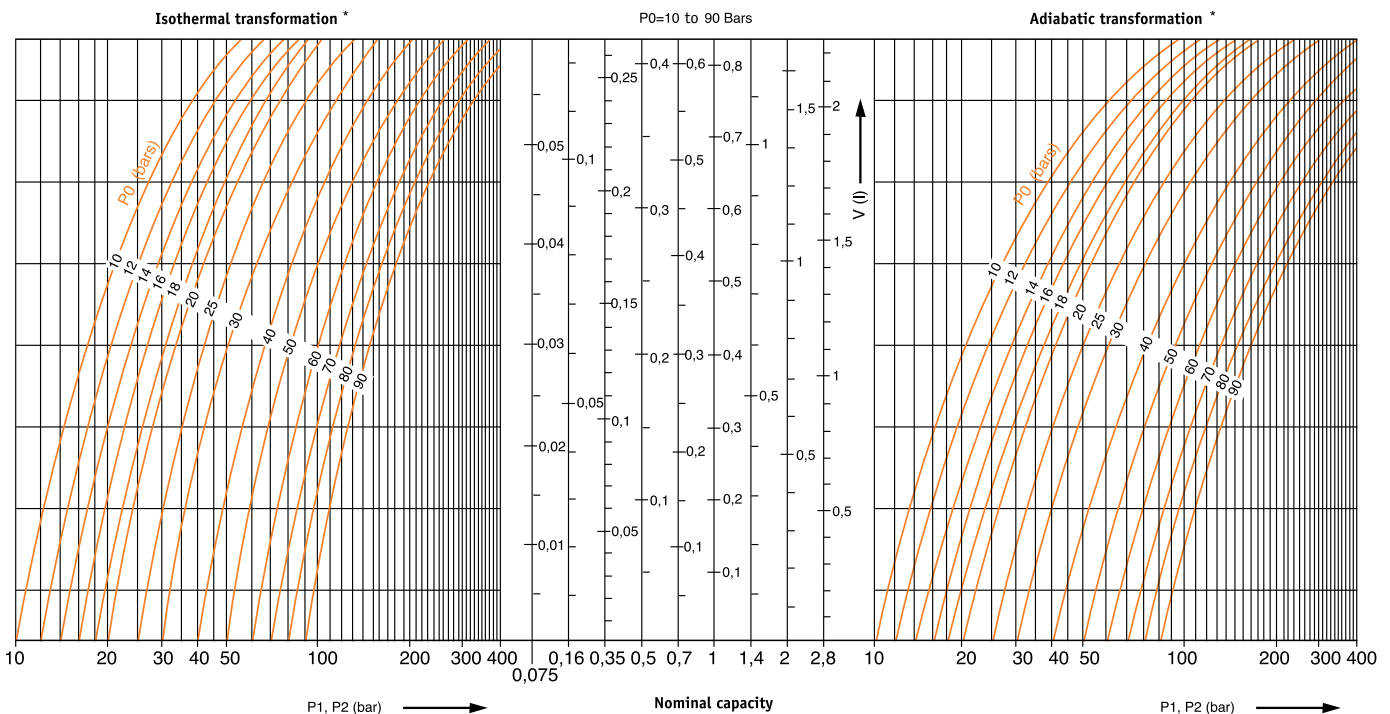

**\*Reminder**

**Isothermal:** The transformation is said to be isothermal when the compression or expansion of the gas occurs at a rate slow enough to allow a good thermal exchange, allowing the gas to remain at constant temperature.

**Adiabatic:** The transformation is said to be adiabatic when the cycle is quick and does not allow a temperature exchange with the ambient media.

# Technical Characteristics

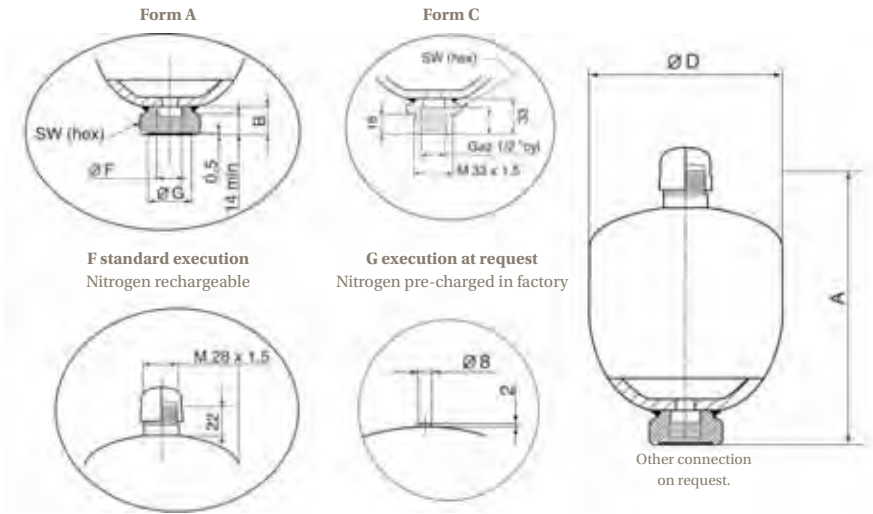

Type	Effective Gas vol. Litres	Work pressure (PS) bar	Execution form	Max. Precharge in bar	Max compression in bar ratio P2/P0	Max Pressure amplitude P2/P1	Weight in kg	Dimensions in mm					Oilport		Clamp type	Lock nut type
								A max Height	B	SW	D	G	F	H		
ELM 0.075-250/00/AF*	0.075	250	AF	130	8	210	0.7	112	22	32	64	29	G½	-	-	-
ELM 0.16-250/00/AF*	0.16	250	AF	130	6	210	1	120	20	32	75	29	G½	-	-	-
ELM 0.32-210/85/AF*	0.32	210	AF	130	8	140	1.4	134	20	32	93	29	G½	-	E95	-
ELM 0.50-210/85/AF*	0.50	210	AF	130	8	175	2	153	22	41	106	34	G½	-	E106	-
ELM 0.50-210/85/CF*	0.50	210	CF	130	8	175	2	163	22	41	106	-	G½	M33x1.5	E106	M33
ELM 0.75-210/85/AF*	0.75	210	AF	130	8	175	2.6	166	22	41	122	34	G½	-	E114	-
ELM 0.75-210/85/CF*	0.75	210	CF	130	8	175	2.6	177	33	41	122	-	G½	M33x1.5	E114	M33
ELM 0.75-350/85/AF*	0.75	350	AF	130	8	150	4	168	18	41	133	34	G½	-	E136	-
ELM 0.75-350/85/CF*	0.75	350	CF	130	8	150	4	184	18	41	133	-	G½	M33x1.5	E136	M33
ELM 1-210/85AF*	1	210	AF	130	8	170	3.5	180	22	41	136	34	G½	-	E136	-
ELM 1-210/85/CF*	1	210	CF	130	8	170	3.5	191	33	41	136	-	G½	M33x1.5	E136	M33
ELM 1.4-140/88/AF	1.40	140	AF	130	8	120	4.1	191	22	41	148	34	G½	-	E155	-
ELM 1.4-140/88/CF	1.40	140	CF	130	8	120	4.1	202	33	41	148	-	G½	M33x1.5	E155	M33
ELM 1.4-210/88/AF	1.40	210	AF	130	8	120	4.2	191	22	41	148	34	G½	-	E155	-
ELM 1.4-210/88/CF	1.40	210	CF	130	8	120	4.2	202	33	41	148	-	G½	M33x1.5	E155	M33
ELM 1.4-250/88/AF	1.40	250	AF	130	8	140	5.5	199	22	41	155	34	G½	-	E155	-
ELM 1.4-250/88/CF	1.40	250	CF	130	8	140	5.5	209	33	41	155	-	G½	M33x1.5	E155	M33
ELM 1.4-350/88/AF	1.40	350	AF	130	8	150	7	199	20	41	160	34	G½	-	E155	-
ELM 1.4-350/88/CF	1.40	350	CF	130	8	150	7	220	20	41	160	-	G½	M33x1.5	E155	M33
ELM 2-100/88/AF	2	100	AF	90	8	80	3.5	240	22	41	144	34	G½	-	E155	-
ELM 2-250/88/AF	2	250	AF	130	8	140	9.5	251	22	41	155	33	G¾	-	E180	-
ELM 2-350/88/AF	2	350	AF	130	8	200	9.5	219	22	55	180	34	G¾	-	E180	-
ELM 2-350/88/CF	2	350	CF	130	8	200	9.5	240	22	55	180	-	G¾	M45x1.5	E180	M45
ELM 2.8-250/88/AF	2.80	250	AF	130	6	140	10	268	21	41	174	34	G¾	-	E180	-
ELM 2.8-350/88/AF	2.80	350	AF	130	6	200	14.3	264	21	55	180	34	G¾	-	E180	-
ELM 2.8-350/88/CF	2.80	350	CF	130	6	200	14.3	285	21	55	180	-	G¾	M45x1.5	E180	M45
ELM 3.5-250/88/AF	3.50	250	AF	130	4	140	11	307	21	41	174	33	G¾	-	E180	-
ELM 3.5-350/88/AF	3.50	350	AF	130	4	200	16	304	21	55	180	34	G¾	-	E180	-
ELM 3.5-350/88/CF	3.50	350	CF	130	4	200	16	325	21	55	180	-	G¾	M45x1.5	E180	M45
ELM 0.75-160/85/CF <sup>(1)</sup>	0.75	160	CF	130	8	120	2.6	176	33	41	121	-	G½	-	E114	-

\* According to the PED, article 3.3

<sup>(1)</sup> Stainless steel version

Above dimensions are in mm and are subject to manufacturing tolerances.

# Accessories

## Clamps

Type	Form	Recommended min/max diameter	Dimensions in mm											Recommended tightening torque N.m.	
			A	B	C		D	E	F	G	H	I	J		K
					Min	Max									
E95	E	87/97	88	140	61.5	66.5	1.5	28	M8x75	3	40	35	9	210	7
E106	E	99/109	88	140	68	73	1.5	28	M8x75	3	40	35	9	210	7
E114	E	112/124	88	140	73	78	1.5	28	M8x75	3	40	35	9	210	7
E136	E	128/138	88	140	80	85	1.5	28	M8x75	3	40	35	9	210	7
E155	E	146/157	137	189	81	86.5	1.7	30	M10x80	3	45	35	9	210	10.5
E168	E	166/176	137	189	92	96	1.7	30	M10x80	3	45	35	9	210	10.5
E180	E	178/184	137	189	97	100	2	35	M10x80	4	65	35	9	210	10.5

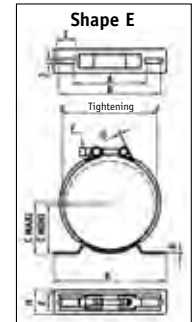

## Lock-nut

Type	Pitch	A	B	C
M33	1.5	50	57.5	10
M45	1.5	70	80.8	10

Above dimensions are in mm and are subject to manufacturing tolerances. These accessories are designed so that the accumulator can be securely attached in all configurations.

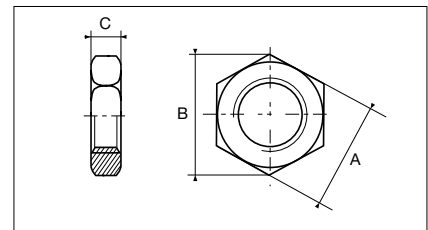

## Charging set VGU

The VGU universal tester and presurizer is an indispensable instrument for the verification, pressurization and nitrogen bleeding of most of the hydraulic accumulators available on the market. To use this unit, it is screwed on the inflation valve of the accumulator and connected via a high pressure hose to the nitrogen source, equipped with a pressure reducer. If only the nitrogen pressure is to be controlled or reduced, this hose is not necessary.

The standard set is delivered in a storage case containing the following:  
VGU universal tester and pressuriser (end M28x1.50)

- Pressure gauge kit from 0 to 25 bar
- Pressure gauge kit from 0 to 250 bar
- Connection adapters for inflation valves (7/8" - 5/8" - 8V1 - M28x1.50)
- High pressure hose, 2.5 m long, for connecting to a nitrogen source
- Hexagon socket screw key 6 mm
- Seal Kit
- Operating instruction in French, English, German

### Note:

The following options are available on request:

Pressure gauge kits with different scale divisions: 63 mm with glycerol filled back end G1/4" cyl. equipped with direct gear for Minimesse® connection. Scale divisions 0-10, 0-60, 0-100, 0-400, with accuracy class 1.6%.

High pressure hose of different length with adapters for nitrogen bottles from various countries (specify country), at each end with a female swivel coupling G1/4" for connecting to the inflation port  
Maximum working pressure: limited by the maximum operating hydraulic system, pressure limited to **400 bar in any case.**

### Ordering code - Example:

VGU/F 25/250 7 TS2 3  
25/250 = Gauges, possible choice between pressure ranges 6/10/25/60/100/160/250/400



## Safety Blocks

Are designed to incorporate in a single compact block a variety of functions necessary for the correct operation of a hydraulic system fitted with accumulators. This includes manual and/or electrical drain, isolation, flow control and pressure relief.

Channel cross section : 10 mm (DI 10 block), 20 mm (DI 20 block).

Maximum working pressure : 330 to 690 Bar depending on models. According with the fluids of group 2 (PED). Options for ATEX compliant blocks construction carbon steel or stainless steel. A specific data sheet is available on request, please contact Parker Olaer.

### Function Blocks

Parker Olaer has a broad range of function blocks adapted to your specific use. Contact Parker Olaer for further information.



# How to order?

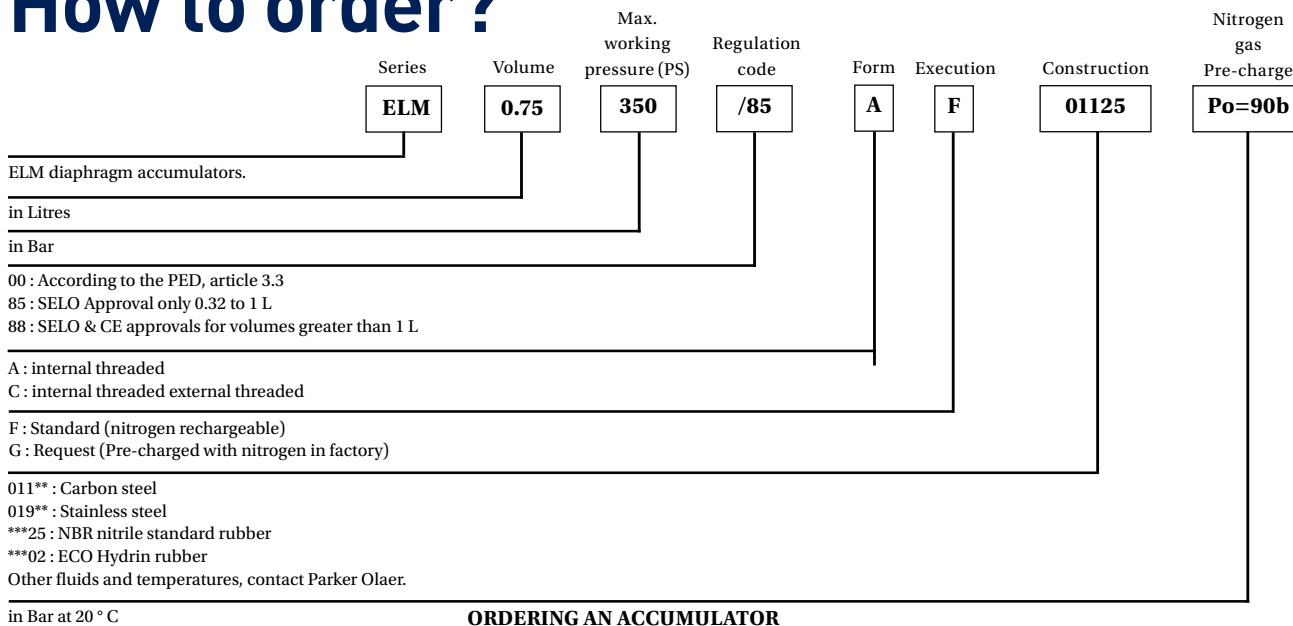

## ORDERING AN ACCUMULATOR

Please indicate type for accessories as per tables on page 6, and for peripheral materials.

# Installation

**Position:** Preferably vertical (liquid connection downwards) to horizontal, depending upon application. If the accumulator is installed in any position other than vertical with fluid port down, contact Parker Olaer. The accumulator could have reduced volumetric efficiency and Parker Olaer can help you to take these factors into account.

**Mounting:** A 200mm clearance is required above the accumulator to allow for gas charging. Each accumulator is delivered with a user instructions leaflet. Ensure that the pipes connected directly or indirectly to the accumulator are not subjected to any abnormal force, Ensure that the accumulator cannot move, or minimise any movement that may occur as a result of broken connections. Parker Olaer clamps and brackets are designed for this purpose (and can be supplied as optional extras). The accumulator must not be subjected to any stress or load, in particular from the structure with which it is associated. Contact Parker Olaer in case of mounting on the movable structures.

### IT IS STRICTLY FORBIDDEN TO

- Weld, screw or rivet anything onto the accumulator body.
- Operate in any way that may alter the mechanical properties of the accumulator.

- Use the accumulator for construction purposes. (No stress or loading)
- To modify the accumulator without prior approval from the manufacturer.

### GAS FILLING

For safety reasons, use only pure nitrogen, minimum 99.8% purity. In most of the cases the pre-charge pressure is between 0,9 P1 and 0,25 P2. Your local Parker Olaer office can calculate the correct pre-charge pressure for your application.

Parker Olaer offers a range of devices for checking nitrogen pressure as well as pre-charging accumulators. Please note that various adaptors are required to interface with different accumulator filling valves and nitrogen (N2) cylinder connections throughout the world.

The part number defines the accumulator and the material construction.

Information contained on the labeling/ manufacturer's plate:

- Parker Olaer logo
- Reference Parker Olaer
- Volume
- Max. allowable working Pressure (PS)
- Working temperature range (TS)
- Parker Olaer SELO Identification

- Test pressure (PT)
- Fluid group (1 or 2 according to the PED Directive 97/23/EC)
- Gas
- Pre-charge pressure
- Serial production n°
- Parker Olaer Warning Label

### Maximum allowable operating pressure

The maximum pressure (PS) is indicated on the accumulator. Check that the maximum allowable pressure is greater than that of the hydraulic system. For any other pressure, you will have to contact Parker Olaer.

### Maximum allowable operating temperature

The temperature range (TS) is indicated on the accumulator. Check that the allowable temperature range covers the operating temperatures (environment and hydraulic fluid temperatures). For any other temperature, you will have to contact Parker Olaer.

### Maintenance

Any intervention, maintenance, repair must be carried out by a qualified and trained personnel.



# Parker Worldwide

**AE – UAE, Dubai**  
Tel: +971 4 8127100  
parker.me@parker.com

**AR – Argentina, Buenos Aires**  
Tel: +54 3327 44 4129

**AT – Austria, Wiener Neustadt**  
Tel: +43 (0)2622 23501-0  
parker.austria@parker.com

**AT – Eastern Europe, Wiener Neustadt**  
Tel: +43 (0)2622 23501 900  
parker.easteurope@parker.com

**AU – Australia, Castle Hill**  
Tel: +61 (0)2-9634 7777

**AZ – Azerbaijan, Baku**  
Tel: +994 50 2233 458  
parker.azerbaijan@parker.com

**BE/LU – Belgium, Nivelles**  
Tel: +32 (0)67 280 900  
parker.belgium@parker.com

**BR – Brazil, Cachoeirinha RS**  
Tel: +55 51 3470 9144

**BY – Belarus, Minsk**  
Tel: +375 17 209 9399  
parker.belarus@parker.com

**CA – Canada, Milton, Ontario**  
Tel: +1 905 693 3000

**CH – Switzerland, Etoy**  
Tel: +41 (0)21 821 87 00  
parker.switzerland@parker.com

**CL – Chile, Santiago**  
Tel: +56 2 623 1216

**CN – China, Shanghai**  
Tel: +86 21 2899 5000

**CZ – Czech Republic, Klecany**  
Tel: +420 284 083 111  
parker.czechrepublic@parker.com

**DE – Germany, Kaarst**  
Tel: +49 (0)2131 4016 0  
parker.germany@parker.com

**DK – Denmark, Ballerup**  
Tel: +45 43 56 04 00  
parker.denmark@parker.com

**ES – Spain, Madrid**  
Tel: +34 902 330 001  
parker.spain@parker.com

**FI – Finland, Vantaa**  
Tel: +358 (0)20 753 2500  
parker.finland@parker.com

**FR – France, Contamine s/Arve**  
Tel: +33 (0)4 50 25 80 25  
parker.france@parker.com

**GR – Greece, Athens**  
Tel: +30 210 933 6450  
parker.greece@parker.com

**HK – Hong Kong**  
Tel: +852 2428 8008

**HU – Hungary, Budapest**  
Tel: +36 1 220 4155  
parker.hungary@parker.com

**IE – Ireland, Dublin**  
Tel: +353 (0)1 466 6370  
parker.ireland@parker.com

**IN – India, Mumbai**  
Tel: +91 22 6513 7081-85

**IT – Italy, Corsico (MI)**  
Tel: +39 02 45 19 21  
parker.italy@parker.com

**JP – Japan, Tokyo**  
Tel: +81 (0)3 6408 3901

**KR – South Korea, Seoul**  
Tel: +82 2 559 0400

**KZ – Kazakhstan, Almaty**  
Tel: +7 7272 505 800  
parker.easteurope@parker.com

**MX – Mexico, Apodaca**  
Tel: +52 81 8156 6000

**MY – Malaysia, Shah Alam**  
Tel: +60 3 7849 0800

**NL – The Netherlands, Oldenzaal**  
Tel: +31 (0)541 585 000  
parker.nl@parker.com

**NO – Norway, Asker**  
Tel: +47 66 75 34 00  
parker.norway@parker.com

**NZ – New Zealand, Mt Wellington**  
Tel: +64 9 574 1744

**PL – Poland, Warsaw**  
Tel: +48 (0)22 573 24 00  
parker.poland@parker.com

**PT – Portugal, Leca da Palmeira**  
Tel: +351 22 999 7360  
parker.portugal@parker.com

**RO – Romania, Bucharest**  
Tel: +40 21 252 1382  
parker.romania@parker.com

**RU – Russia, Moscow**  
Tel: +7 495 645-2156  
parker.russia@parker.com

**SE – Sweden, Spånga**  
Tel: +46 (0)8 59 79 50 00  
parker.sweden@parker.com

**SG – Singapore**  
Tel: +65 6887 6300

**SK – Slovakia, Banská Bystrica**  
Tel: +421 484 162 252  
parker.slovakia@parker.com

**SL – Slovenia, Novo Mesto**  
Tel: +386 7 337 6650  
parker.slovenia@parker.com

**TH – Thailand, Bangkok**  
Tel: +662 717 8140

**TR – Turkey, Istanbul**  
Tel: +90 216 4997081  
parker.turkey@parker.com

**TW – Taiwan, Taipei**  
Tel: +886 2 2298 8987

**UA – Ukraine, Kiev**  
Tel: +380 44 494 2731  
parker.ukraine@parker.com

**UK – United Kingdom, Warwick**  
Tel: +44 (0)1926 317 878  
parker.uk@parker.com

**US – USA, Cleveland**  
Tel: +1 216 896 3000

**VE – Venezuela, Caracas**  
Tel: +58 212 238 5422

**ZA – South Africa, Kempton Park**  
Tel: +27 (0)11 961 0700  
parker.southafrica@parker.com

## EMEA Product Information Centre

Free phone: 00 800 27 27 5374

(from AT, BE, CH, CZ, DE, DK, EE, ES, FI, FR, IE, IL, IS, IT, LU, MT, NL, NO, PL, PT, RU, SE, SK, UK, ZA)

## US Product Information Centre

Toll-free number: 1-800-27 27 537

www.parker.com

